

013R9277

013R9277

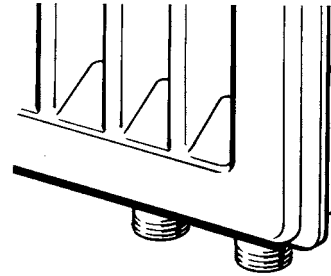
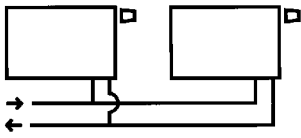

**G 3/4 A**

30 - 40 Nm

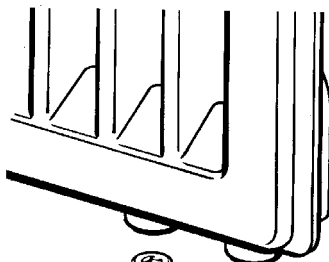
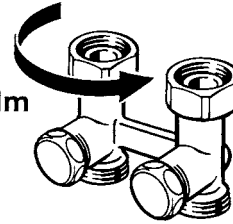

**G 1/2**

10 mm

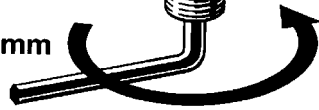

30 - 40 Nm

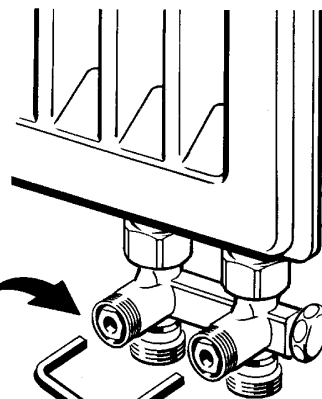
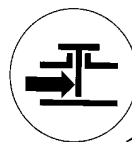
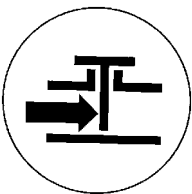
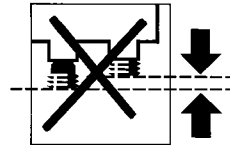
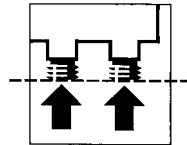
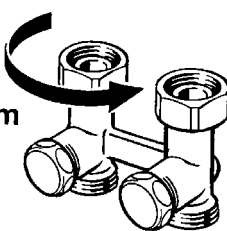

6 mm